

For reference only. See data sheet for the detailed specifications.

Technical Specification

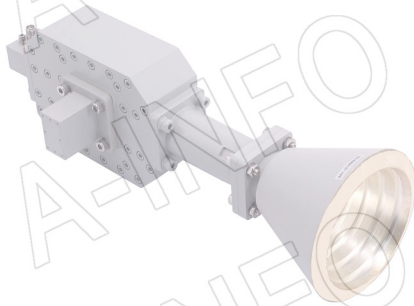

Frequency Range(GHz)	10.0 - 15.0
Waveguide	WR75
Gain(dBi)	15 Typ.
Polarization	Dual Linear
3dB Beamwidth(deg)	E Plane: 28 Typ.
	H Plane: 27 Typ.
Cross Pol. Isolation(dB)	45 Typ.
Port to Port Isolation(dB)	55 Typ. ; 45 Min.
VSWR	A Type: 1.50:1 Typ.
	C Type: 1.60:1 Typ.
Output	A Type: FBP120(UBR120) (modified with 4xM4 D6)
	C Type: SMA-Female or N-Female or TNC-Female or 7mm or 3.5mm-Female
Material	Al
Finish	Silver Plated and Chemical Conversion Coating, Gray Paint
Size(mm)	A Type: 81.3 x 81.3 x 234.2
	C Type: 89.7 x 81.3 x 264.2
Net Weight(Kg)	A Type: 0.95 Around
	C Type: 1.05 Around

Outline Drawing (Size: mm)

FBP120 Output (P/N: LB-CH-75-15-T02-A)

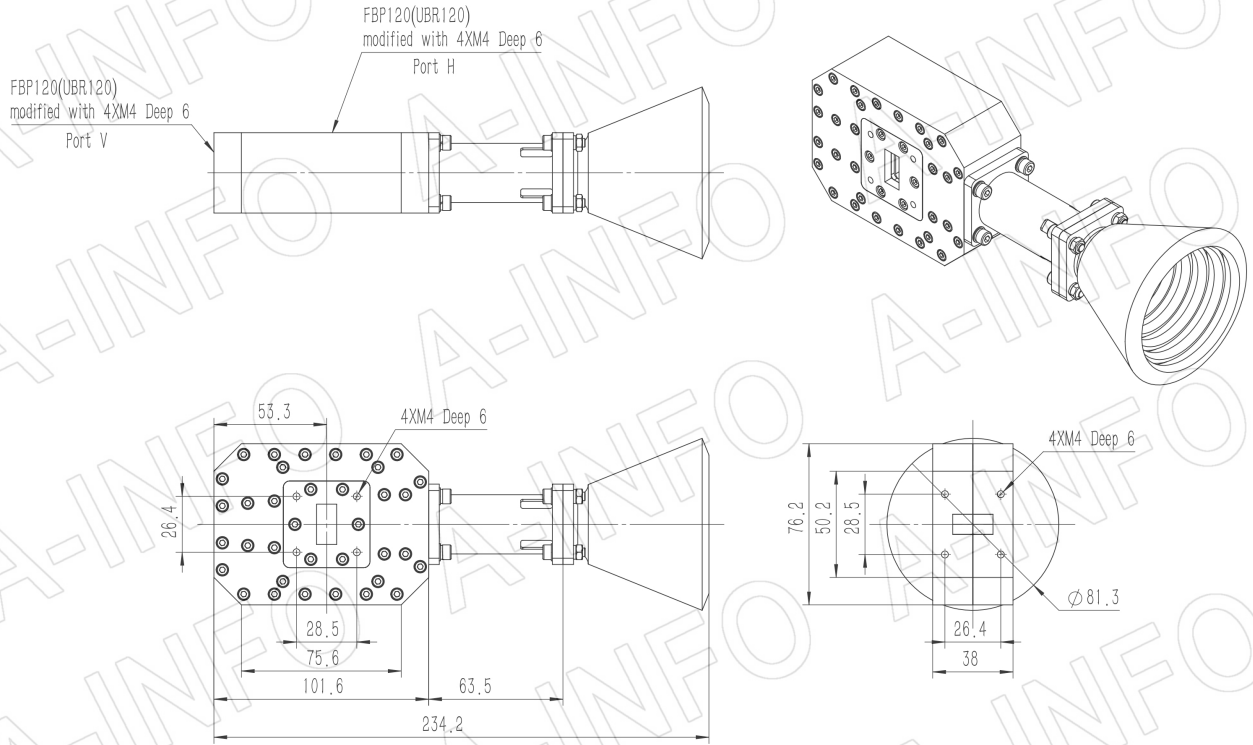

SMA-Female Output (P/N: LB-CH-75-15-T02-C-SF)

For N-Female, TNC-Female, 7mm or 3.5mm-Female output outline drawing, please contact A-INFO.

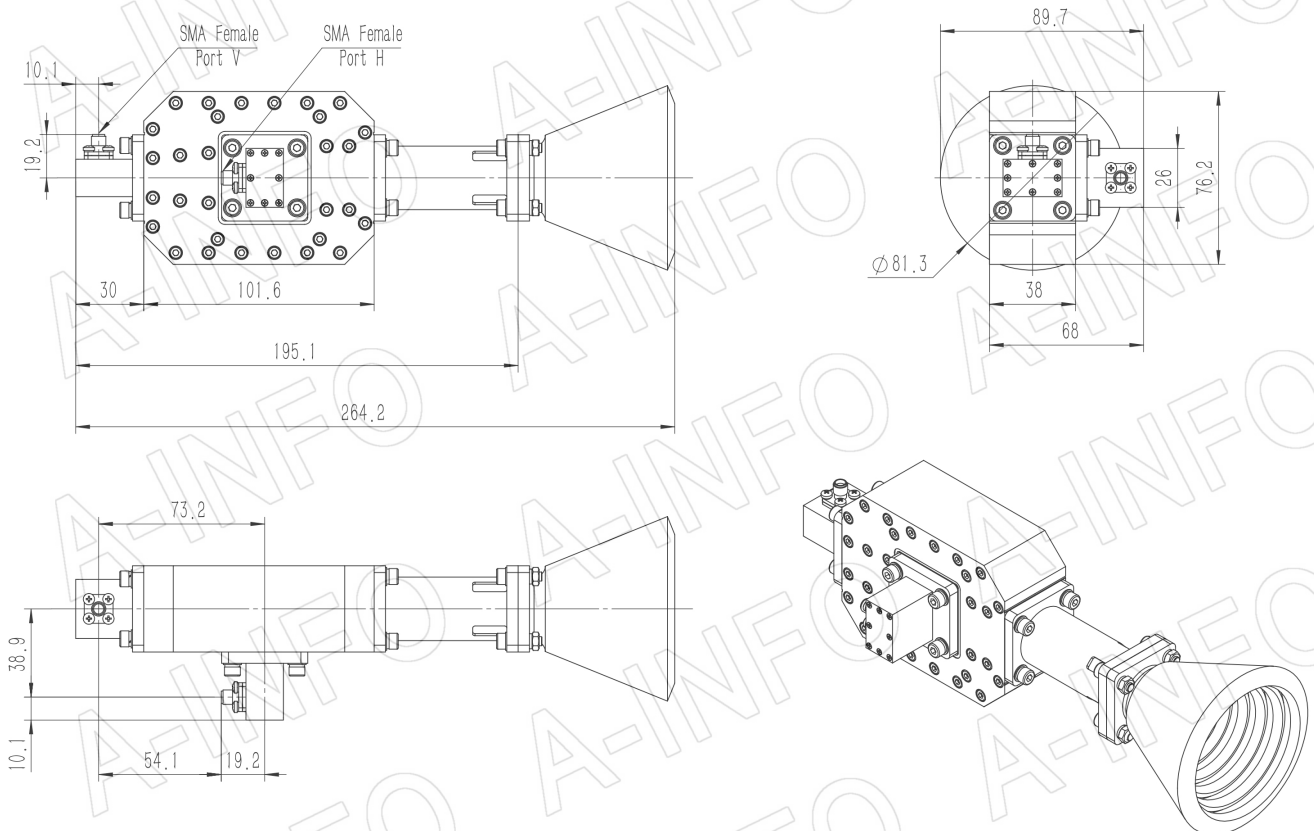

Flange Drawing (Size: mm)

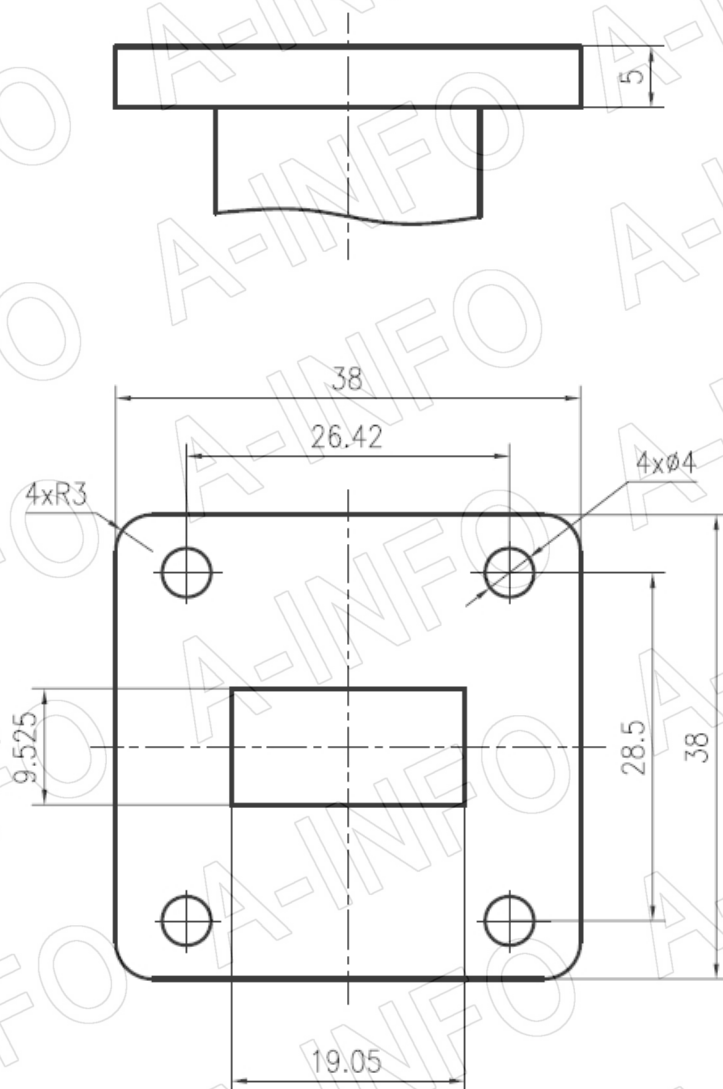

FBP120

AINFO Inc.

China(Beijing): Tel: (+86) 10-6266-7326,
China(Chengdu): Tel: (+86) 28-8519-2786,
USA : Tel: (+1) 949-639-9688,

Page 3 of 9

(+86) 10-6266-7327 Fax: (+86) 10-6266-7379
(+86) 28-8519-3044 Fax: (+86) 28-8519-3068
(+1) 949-639-9608 Fax: (+1) 949-639-9670

Website: www.ainfoinc.com
Email: sales@ainfoinc.com

Test Results

1. Gain & Antenna Factor

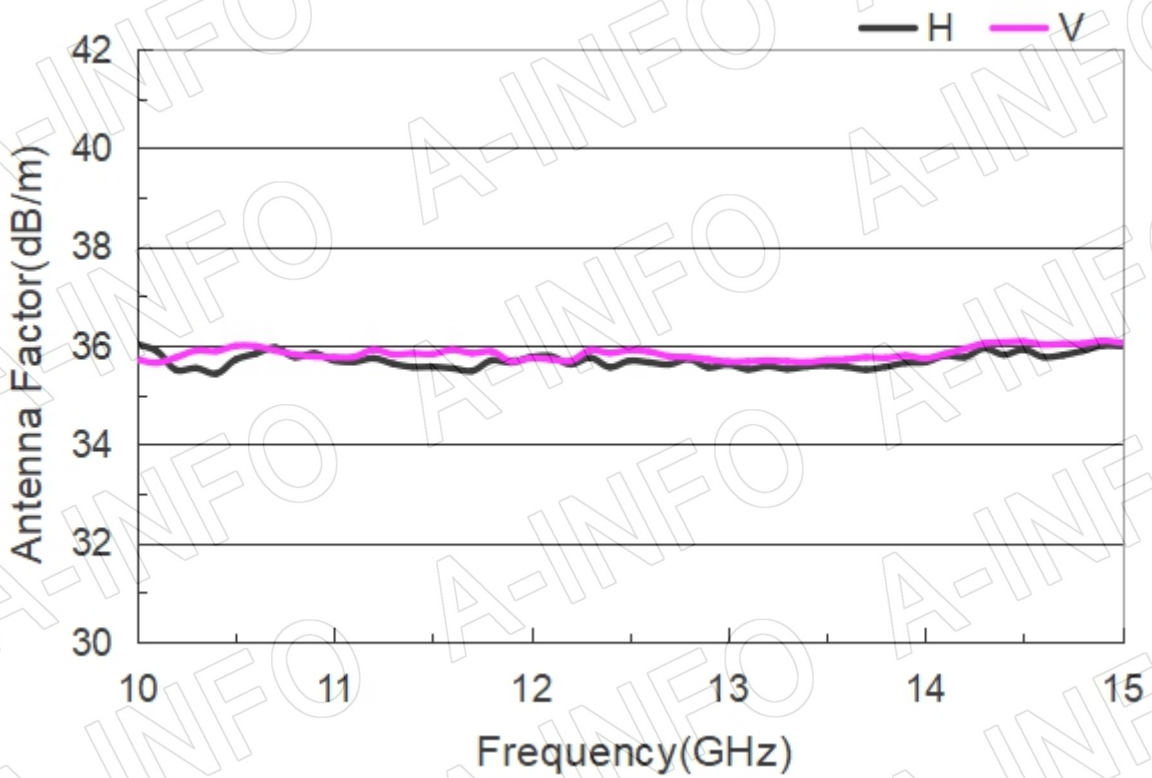
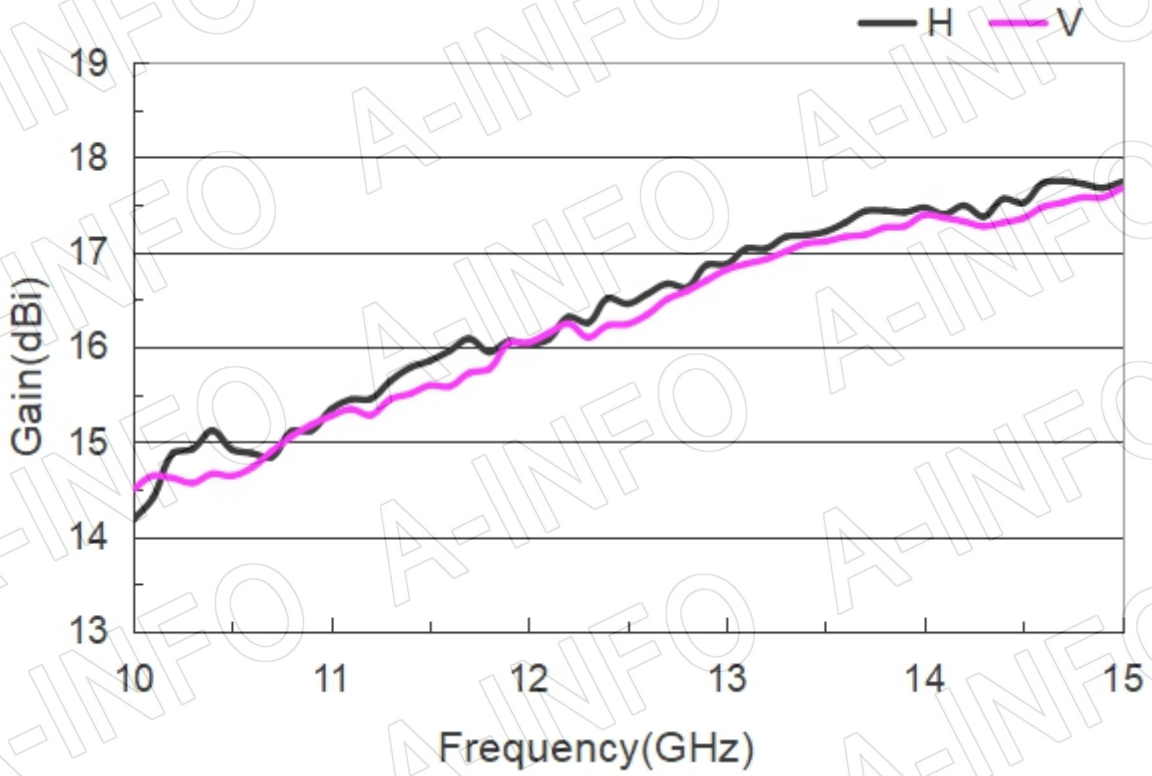

2. Cross Polarization Isolation

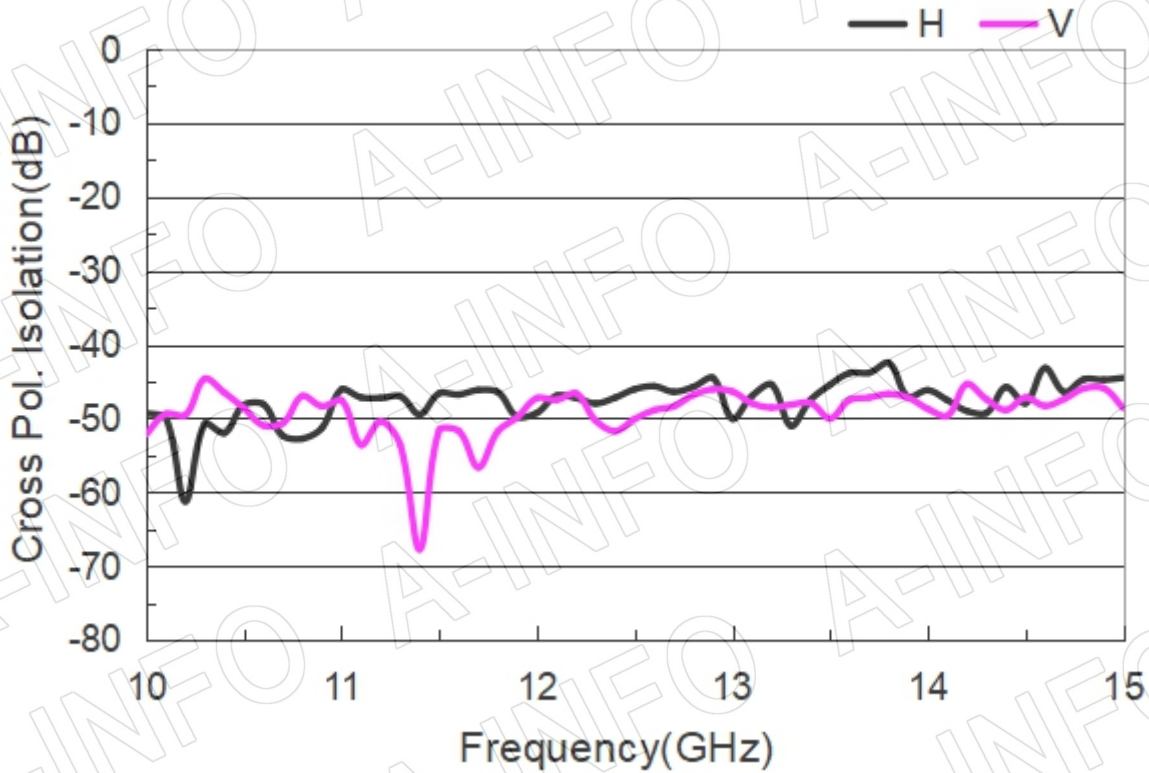

3. Port to Port Isolation

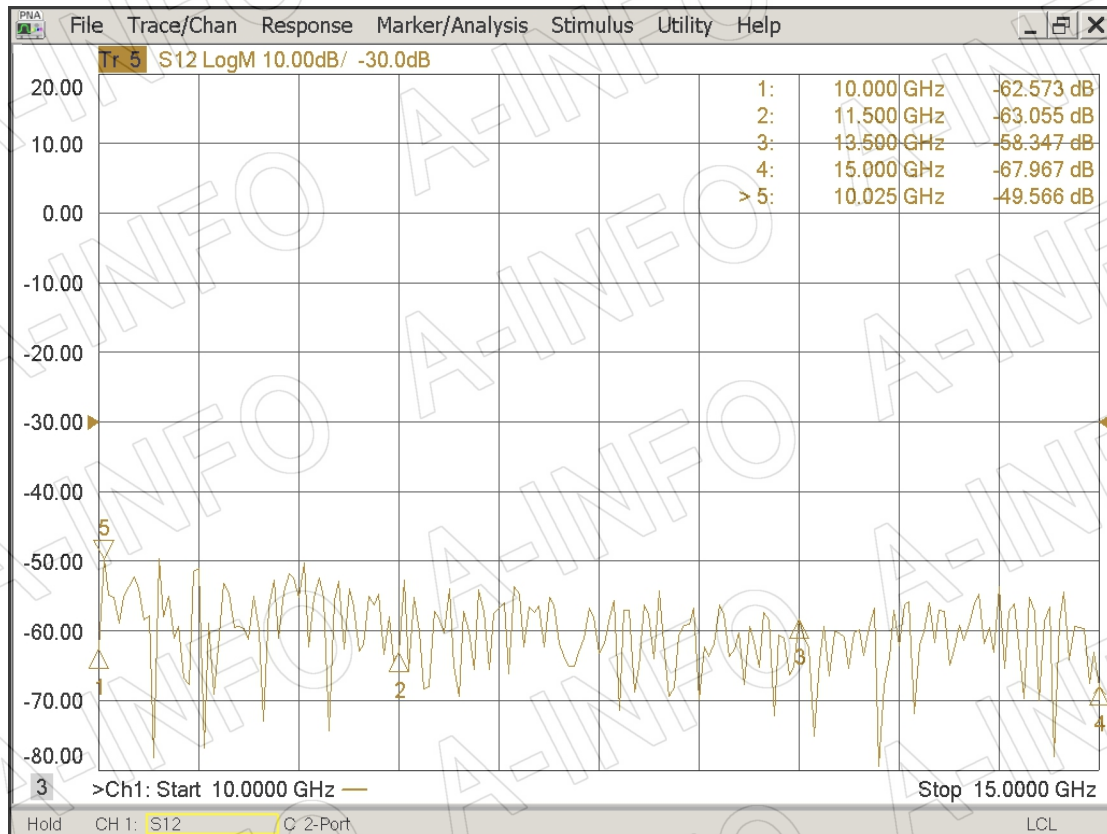

4. VSWR_A Type

Port-H

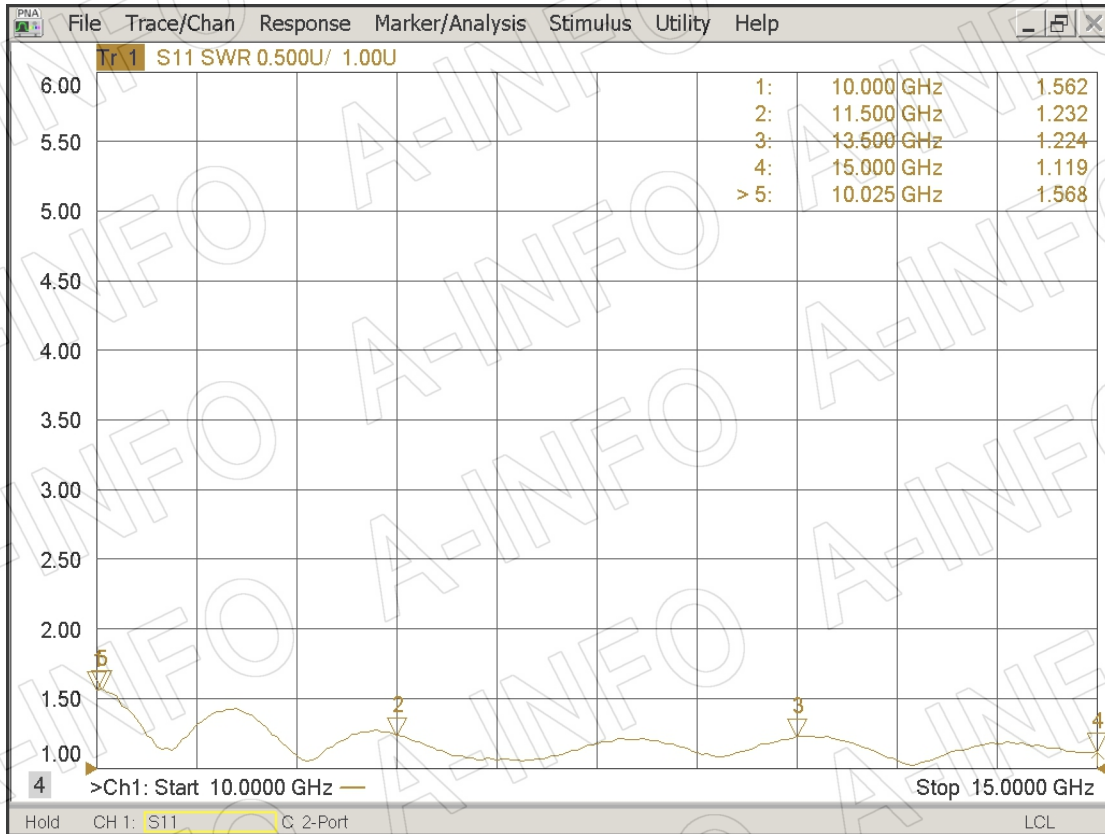

Port-V

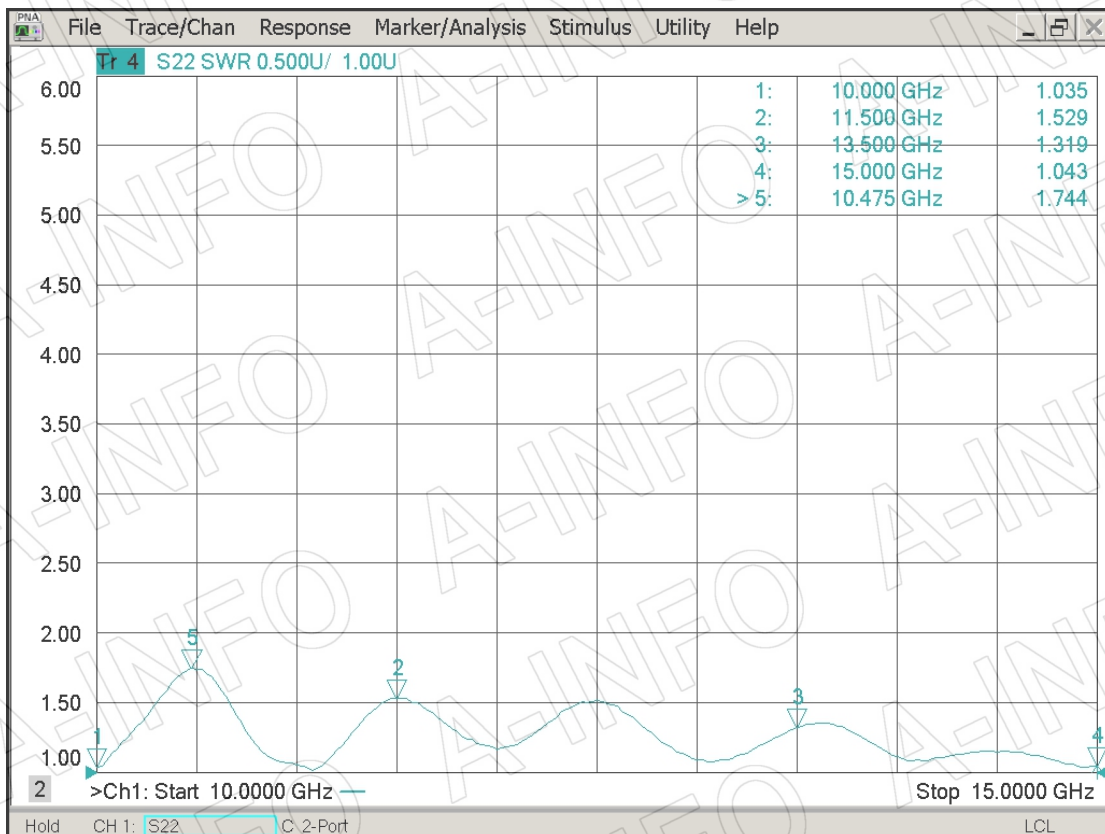

VSWR_C Type

Port-H

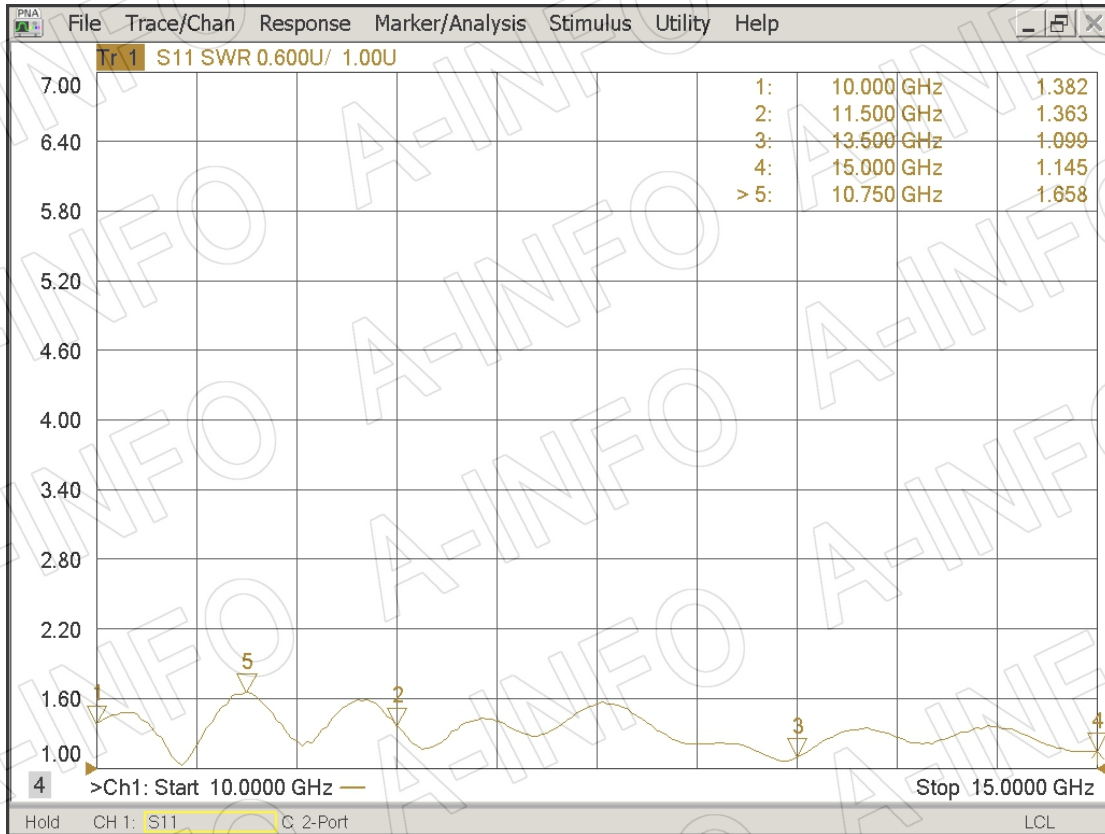

Port-V

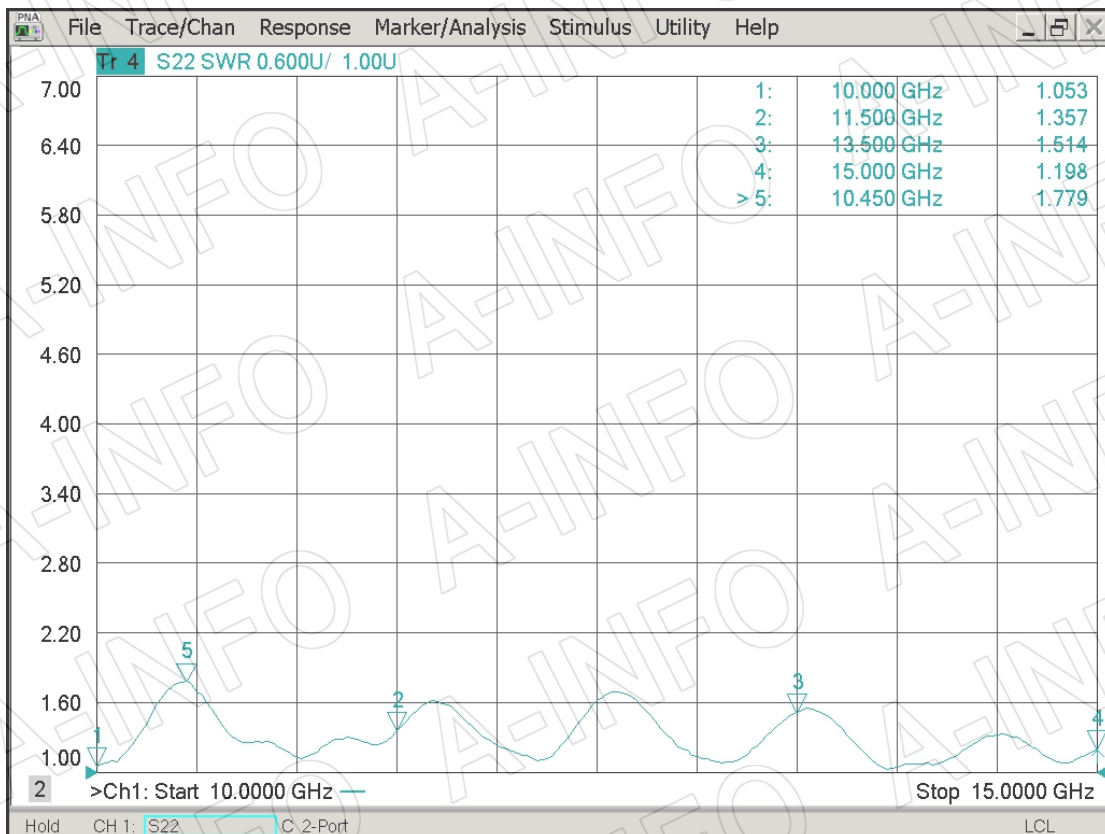

5. Pattern

